

MANSON[®] LINEAR FF BALUSTRADE

THE MANSON LINEAR BALUSTRADE SYSTEM ADDS
A CLEAN, CONTEMPORARY AESTHETIC WHILE ALSO BEING
EXTREMELY ADAPTABLE.

Built in New Zealand using ultra-durable, marine-grade materials materials, the Manson Linear Balustrade can span in-between levels, making it perfect for multi-level developments.

MANSON® LINEAR BALUSTRADE

GENERAL ARRANGEMENT

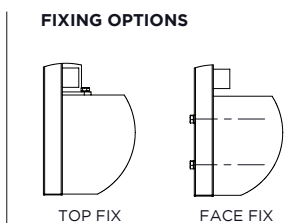
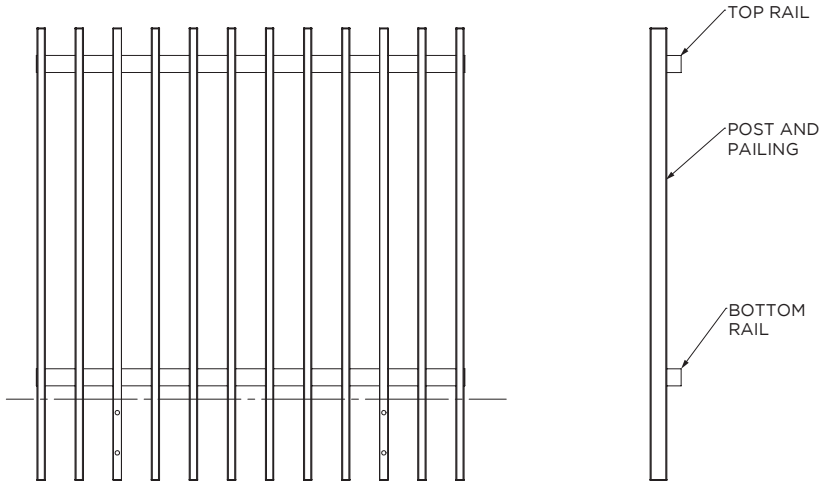

FEATURES

- Designed to ensure minimal visible fixings
- Easily configured to fit any sized space
- Fins can span between levels to create full height privacy screens
- Can be top or faced fix to suit your requirements
- New Zealand made using highly durable marine-grade materials
- 316 Stainless Steel fixings
- NZBC Compliant:
 - B1 Structure
 - B2 Durability
 - D1 Access Routes
 - F4 Safety from Falling
 - F9 Pool Fencing
- Occupancy Types: A, B, E & C3
- Custom sections available on request

FINISHES

A wide range of exterior Powdercoat finishes are available. Duralloy or equivalent is the standard finish supplied unless stated otherwise and provides excellent resistance to weather and salt spray.



POWDERCOAT

WARRANTY

All products installed by Manson Engineering, from the date of invoice, are fully warranted for the first two years. This warranty covers workmanship, louvres, and all componentry, actuators, switches and electronics.

Powdercoating carries a warranty of a maintainable service life of 25 years, film integrity of 10 years and colour integrity of 7 years.

FOR MORE INFORMATION OR DETAILED DESIGN DRAWINGS PLEASE CONTACT US ON 09 218 2494 OR EMAIL INFO@MANSONENGINEERING.CO.NZ

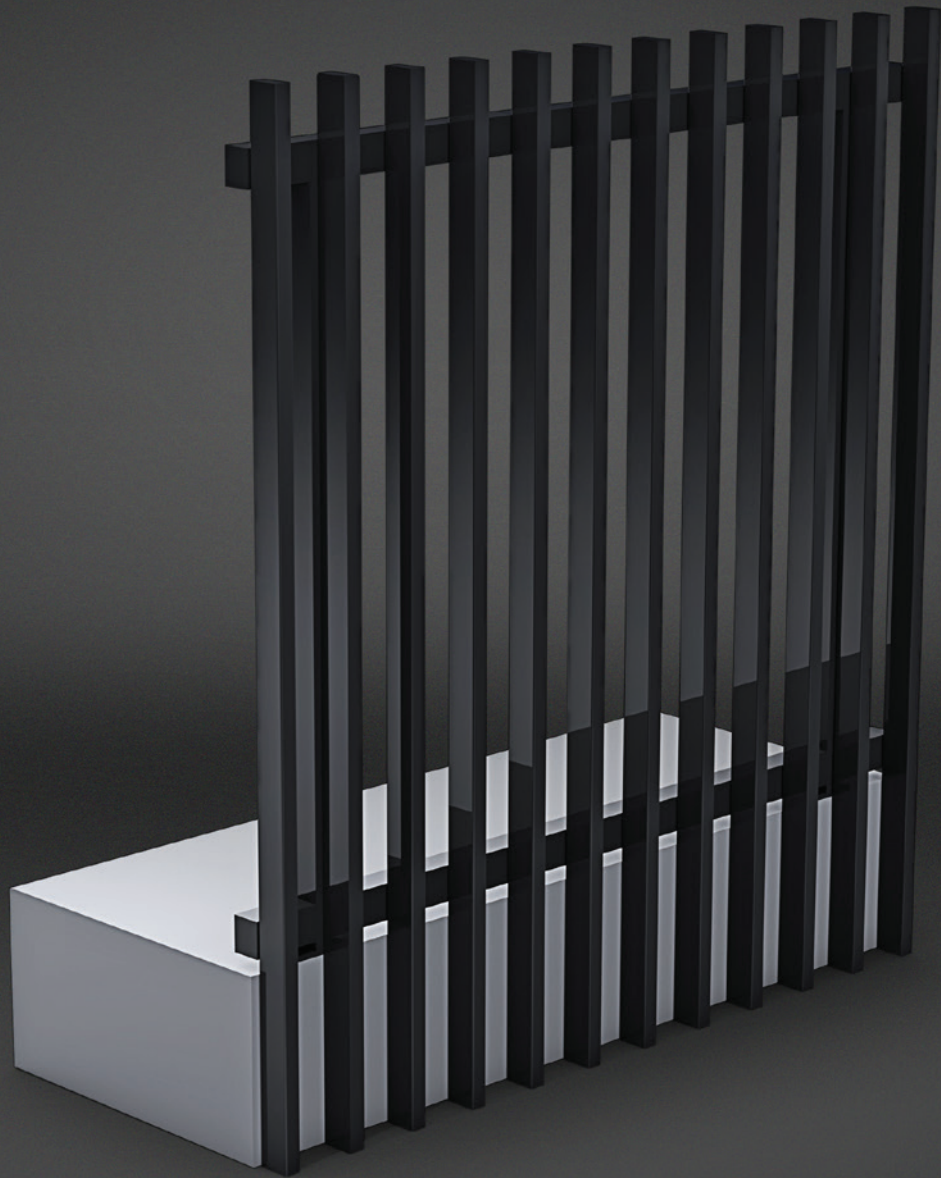

MANSON[®] LINEAR TF BALUSTRADE

THE MANSON LINEAR BALUSTRADE SYSTEM ADDS
A CLEAN, CONTEMPORARY AESTHETIC WHILE ALSO BEING
EXTREMELY ADAPTABLE.

Built in New Zealand using ultra-durable, marine-grade materials materials, the Manson Linear Balustrade can span in-between levels, making it perfect for multi-level developments.

MANSON® LINEAR TF BALUSTRADE

GENERAL ARRANGEMENT

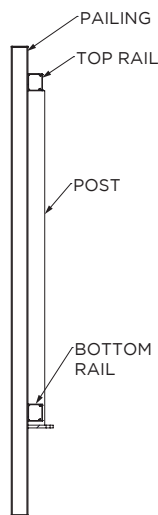
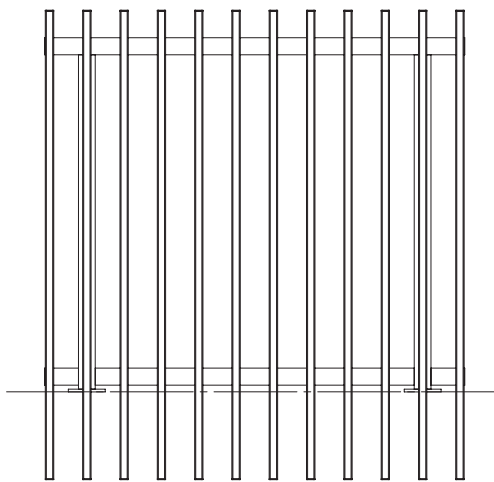

FEATURES

- Designed to ensure minimal visible fixings
- Easily configured to fit any sized space
- Fins can span between levels to create full height privacy screens
- Can be top or faced fix to suit your requirements
- New Zealand made using highly durable marine-grade materials
- 316 Stainless Steel fixings
- NZBC Compliant:
 - B1 Structure
 - B2 Durability
 - D1 Access Routes
 - F4 Safety from Falling
 - F9 Pool Fencing
- Occupancy Types: A, B, E & C3
- Custom sections available on request

FINISHES

A wide range of exterior Powdercoat finishes are available. Duralloy or equivalent is the standard finish supplied unless stated otherwise and provides excellent resistance to weather and salt spray.



POWDERCOAT

WARRANTY

All products installed by Manson Engineering, from the date of invoice, are fully warranted for the first two years. This warranty covers workmanship, louvres, and all componentry, actuators, switches and electronics.

Powdercoating carries a warranty of a maintainable service life of 25 years, film integrity of 10 years and colour integrity of 7 years.

FOR MORE INFORMATION OR DETAILED DESIGN DRAWINGS PLEASE CONTACT US ON 09 218 2494 OR EMAIL INFO@MANSONENGINEERING.CO.NZ

FIXING OPTIONS

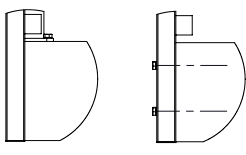

ADDITIONAL HANDRAIL TYPES

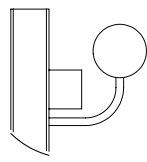

SECTIONS

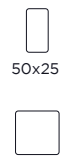



MANSON[®] LINEAR STAIR BALUSTRADE

THE MANSON LINEAR BALUSTRADE SYSTEM ADDS
A CLEAN, CONTEMPORARY AESTHETIC WHILE ALSO BEING
EXTREMELY ADAPTABLE.

Built in New Zealand using ultra-durable, marine-grade materials materials, the Manson Linear Balustrade can span in-between levels, making it perfect for multi-level developments.

MANSON® LINEAR STAIR BALUSTRADE

GENERAL ARRANGEMENT

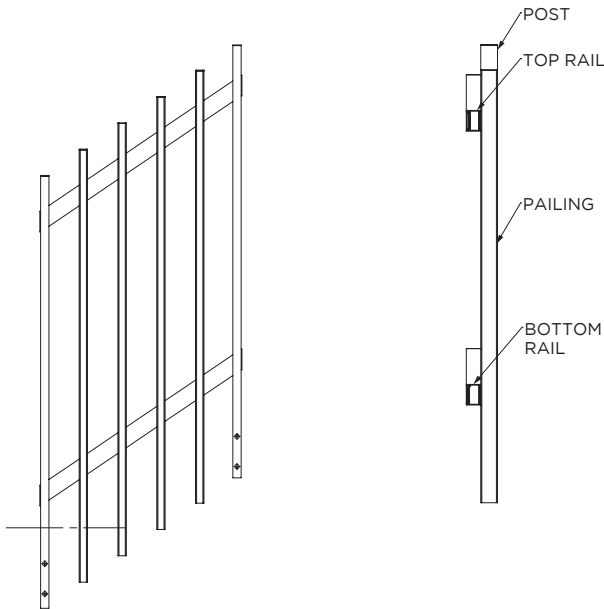

FIXING OPTIONS

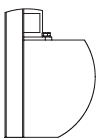

TOP FIX

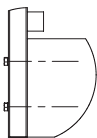

FACE FIX

ADDITIONAL HANDRAIL TYPES

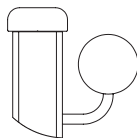

SIDE RAIL

SECTIONS



50x25



50x50

FEATURES

- Designed to ensure minimal visible fixings
- Fins can span between levels to create full height privacy screens
- Easily configured to fit any sized space
- Can be top or faced fix to suit your requirements
- New Zealand made using highly durable marine-grade materials
- 316 Stainless Steel fixings
- NZBC Compliant:
 - B1 Structure
 - B2 Durability
 - D1 Access Routes
 - F4 Safety from Falling
 - F9 Pool Fencing
- Occupancy Types: A, B, E & C3
- Custom sections available on request

FINISHES

A wide range of exterior Powdercoat finishes are available. Duralloy or equivalent is the standard finish supplied unless stated otherwise and provides excellent resistance to weather and salt spray.



POWDERCOAT

WARRANTY

All products installed by Manson Engineering, from the date of invoice, are fully warranted for the first two years. This warranty covers workmanship, louvres, and all componentry, actuators, switches and electronics.

Powdercoating carries a warranty of a maintainable service life of 25 years, film integrity of 10 years and colour integrity of 7 years.

FOR MORE INFORMATION OR DETAILED DESIGN DRAWINGS PLEASE CONTACT US ON 09 218 2494 OR EMAIL INFO@MANSONENGINEERING.CO.NZ